

Partlow DataVU7 Paperless Recorder



- 6 to 18 internal analog inputs
- Up to 24 external inputs
- 5.5" TFT Display
- Up to 24 digital inputs and 7 relay outputs
- Set-up, Comms and Evaluation software
- 144 x 144 mm Front Bezel
- Maths module, batch reports & web server
- Stainless steel version available

Description

The DataVU7 represents a new generation of paperless recorders that stand out through their modular design for the acquisition of measured data (3 to 18 internal inputs can be utilized), the innovative operating concept and high standards of security prevents unauthorized access and manipulation of the stored data.

Within the DataVU7, data can be visualized in process images as measurement curves, as a bar graph or in alphanumeric form.

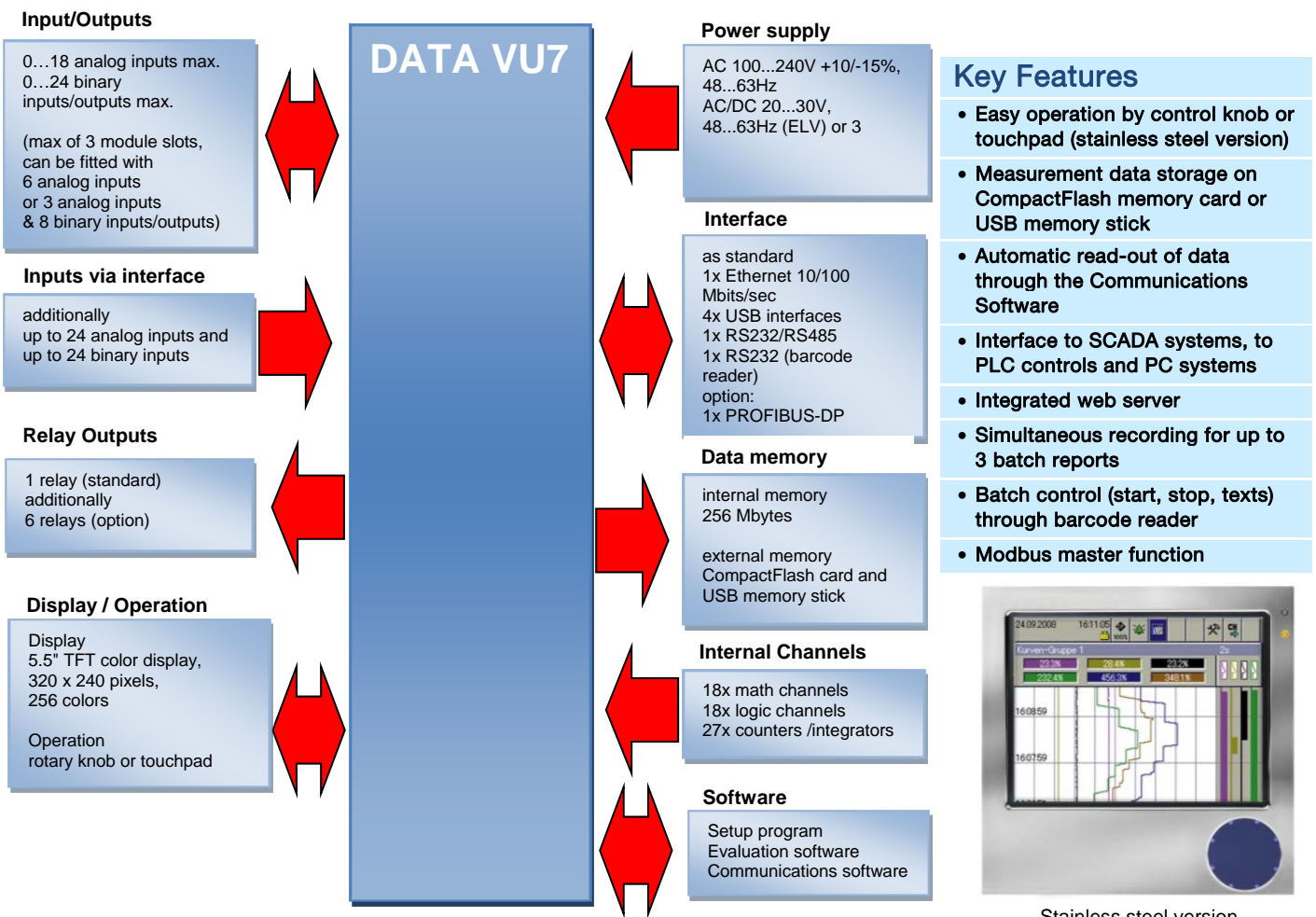

Technical data

Analog inputs

Thermocouple

Designation	Type Standard	Meas. range	Accuracy ¹
Fe-CuNi	L DIN 43 710	-200 to +900 °C	±0.1 %
Fe-CuNi	J EN 60 584	-200 to +1200 °C	±0.1% from -100 °C
Cu-CuNi	U DIN 43 710	-200 to +600 °C	±0.1 % from -150 °C
Cu-CuNi	T EN 60 584	-270 to +400 °C	±0.1 % from -150 °C
NiCr-Ni	K EN 60 584	-200 to +1372 °C	±0.1 % from -80 °C
NiCr-CuNi	E EN 60 584	-200 to +1000 °C	±0.1 % from -80 °C
NiCrSi-NiSi	N EN 60 584	-100 to +1300 °C	±0.1 % from -80 °C
Pt10Rh-Pt	S EN 60 584	0 to 1768 °C	±0.1 5%
Pt13Rh-Pt	R EN 60 584	0 to 1768 °C	±0.15%
Pt30Rh-Pt6Rh	B EN 60 584	0 to 1820 °C	±0.1 5% from 400 °C
W3Re/W25Re	D	0 to 2495 °C	±0.1 5% from 500 °C
W5Re/W26Re	C	0 to 2320 °C	±0.1 5% from 500 °C
W3Re/W26Re		0 to 2400 °C	±0.1 5% from 500 °C
Chromel-copel		-200 to +800 °C	±0.15 % from -80 °C
GOST R 8.585-2001		-200 to +1372 °C	±0.1 % from -80 °C
Chromel-alumel		0 to 1395 °C	±0.15 %
GOST R 8.585-2001			
PL II (Platinel II)			
Minimum span	Type L, J, U, T, K, E, N, chromel-alumel, PL II: 100 °C Type S, R, B, D, C, W3Re/W26Re, chromel-copel: 500 °C		
Range start/end	freely programmable within the limits, in 0.1 °C steps		
Cold junction	Pt100 internal or thermostat external constant		
Cold junction accuracy (internal)	± 1 °C		
Cold junction temperature (external)	-50 to +150 °C adjustable		
Sampling cycle	Channel 1 - 18: 125 ms		
Input filter	2nd order digital filter; filter constant adjustable from 0 to 10.0 sec		
Electrical isolation	see Electrical dat and electrical isolation		
Resolution	> 14 bit		
Features	also programmable in °F		

¹ The linearization accuracy refers to the maximum measuring range. The linearization accuracy is reduced with short spans.

Resistance thermometer

Designation	Standard	Connection circuit	Meas. range	Accuracy ¹	Meas. curr.
Pt100	EN 60 751 (TC = $3.85 \cdot 10^{-3} 1/^{\circ}\text{C}$)	2/3-wire 2/3-wire 4-wire	-200 to +100 °C -200 to +850 °C -200 to +850 °C	±0.5 °C ±0.8 °C ±0.5 °C	≈ 250 μA ≈ 250 μA ≈ 250 μA
Pt100	JIS 1604 (TC = $3.917 \cdot 10^{-3} 1/^{\circ}\text{C}$)	2/3-wire 2/3-wire 4-wire	-200 to +100 °C -200 to +650 °C -200 to +650 °C	±0.5 °C ±0.8 °C ±0.5 °C	≈ 250 μA ≈ 250 μA ≈ 250 μA
Pt100	GOST 6651-94 A.1 (TC = $3.91 \cdot 10^{-3} 1/^{\circ}\text{C}$)	2/3-wire, 4-wire 2/3-wire, 4-wire	-200 to +100 °C -200 to +850 °C	±0.5 °C ±0.8 °C	≈ 250 μA ≈ 250 μA

Pt500	EN (TC = $3.85 \cdot 10^{-3} 1/^{\circ}\text{C}$)	60 751	2/3-wire, 4-wire 2/3-wire, 4-wire	-200 to +100 °C -200 to +850 °C	$\pm 0.5 \text{ }^{\circ}\text{C}$ $\pm 0.9 \text{ }^{\circ}\text{C}$	$\approx 100 \text{ } \mu\text{A}$ $\approx 100 \text{ } \mu\text{A}$
Pt1000	EN (TC = $3.85 \cdot 10^{-3} 1/^{\circ}\text{C}$)	60 751	2/3-wire 2/3-wire 4-wire	-200 to +100 °C -200 to +850 °C -200 to +850 °C	$\pm 0.5 \text{ }^{\circ}\text{C}$ $\pm 0.8 \text{ }^{\circ}\text{C}$ $\pm 0.5 \text{ }^{\circ}\text{C}$	$\approx 100 \text{ } \mu\text{A}$ $\approx 100 \text{ } \mu\text{A}$ $\approx 100 \text{ } \mu\text{A}$
Ni 100	DIN 43 760 (TC = $6.18 \cdot 10^{-3} 1/^{\circ}\text{C}$)		2/3-wire, 4-wire	-60 to +180 °C	$\pm 0.4 \text{ }^{\circ}\text{C}$	$\approx 250 \text{ } \mu\text{A}$
Pt50	ST RGW 1057 1985 (TC = $3.91 \cdot 10^{-3} 1/^{\circ}\text{C}$)		2/3-wire 2/3-wire 4-wire 4-wire	-200 to +100 °C -200 to +1100 °C -200 to +100 °C -200 to +1100 °C	$\pm 0.5 \text{ }^{\circ}\text{C}$ $\pm 0.9 \text{ }^{\circ}\text{C}$ $\pm 0.5 \text{ }^{\circ}\text{C}$ $\pm 0.6 \text{ }^{\circ}\text{C}$	$\approx 250 \text{ } \mu\text{A}$ $\approx 250 \text{ } \mu\text{A}$ $\approx 250 \text{ } \mu\text{A}$ $\approx 250 \text{ } \mu\text{A}$
Cu 50	(TC = $4.26 \cdot 10^{-3} 1/^{\circ}\text{C}$)		2/3-wire 2/3-wire 4-wire 4-wire	-50 to +100 °C -50 to +200 °C -50 to +100 °C -50 to +200 °C	$\pm 0.5 \text{ }^{\circ}\text{C}$ $\pm 0.9 \text{ }^{\circ}\text{C}$ $\pm 0.5 \text{ }^{\circ}\text{C}$ $\pm 0.7 \text{ }^{\circ}\text{C}$	$\approx 250 \text{ } \mu\text{A}$ $\approx 250 \text{ } \mu\text{A}$ $\approx 250 \text{ } \mu\text{A}$ $\approx 250 \text{ } \mu\text{A}$
Cu 100	GOST 6651-94 A.4 (TC = $4.26 \cdot 10^{-3} 1/^{\circ}\text{C}$)		2/3-wire 2/3-wire 4-wire 4-wire	-50 to +100 °C -50 to +200 °C -50 to +100 °C -50 to +200 °C	$\pm 0.5 \text{ }^{\circ}\text{C}$ $\pm 0.9 \text{ }^{\circ}\text{C}$ $\pm 0.5 \text{ }^{\circ}\text{C}$ $\pm 0.6 \text{ }^{\circ}\text{C}$	$\approx 250 \text{ } \mu\text{A}$ $\approx 250 \text{ } \mu\text{A}$ $\approx 250 \text{ } \mu\text{A}$ $\approx 250 \text{ } \mu\text{A}$
Connection circuit	2-, 3-, or 4-wire circuit					
Minimum span	15 °C					
Sensor lead resistance	max. 30 Ω per conductor for 3-wire/4-wire circuit max. 10 Ω per conductor for 2-wire circuit					
Range start/end	freely programmable within the limits, in 0.1 °C steps					
Sampling cycle	Channel 1 - 18: 125 ms in total					
Input filter	2nd order digital filter; filter constant adjustable from 0 to 10 sec					
Electrical isolation	see Electrical dat and electrical isolation					
Resolution	>14 bit					
Features	also programmable in °F					

¹ The linearization accuracy refers to the maximum measuring range. The linearization accuracy is reduced with short spans.

Resistance transmitter and potentiometer

Designation	Meas. range	Accuracy ¹	Meas. curr.
Resistance transmitter	up to 4000 Ω	±4 Ω	≈ 100 μA
Potentiometer	< 400 Ω ≥ 400 Ω to 4000 Ω	±400 mΩ ±4 Ω	≈ 250 μA ≈ 100 μA
Connection circuit	resistance transmitter: 3-wire circuit potentiometer: 2-/3-/4-wire circuit		
Minimum span	60 Ω		
Sensor lead resistance	max. 30 per conductor for 4-wire circuit max. 10 per conductor for 2-/3-wire circuit		
Resistance values	freely programmable within the limits, in 0.1 steps		
Sampling cycle	Channel 1 - 18: 125 ms in total		
Input filter	2nd order digital filter; filter constant adjustable from 0 to 10.0 sec		
Electrical isolation	see Electrical dat and electrical isolation		
Resolution	>14 bit		

¹ The linearization accuracy refers to the maximum measuring range. The linearization accuracy is reduced with short spans.

Input for DC voltage, DC current

Basic range	Accuracy ¹	Input resistance
-12 to +112 mV -10 to +210 mV -1.5 to +11.5 V -0.12 to +1.12 V -1.2 to +1.2 V -11.2 to +11.2 V	±100 μV ±240 μV ±6 mV ±1 mV ±2 mV ±12 mV	R _E ≥ 1 MΩ R _E ≥ 470 kΩ R _E ≥ 470 kΩ R _E ≥ 470 kΩ R _E ≥ 470 kΩ R _E ≥ 470 kΩ
Shortest span	5 mV	
Range start/end	freely programmable within the limits in 0.01 mV steps	
-1.3 to +22 mA -22 to +22 mA	±20 μA ±44 μA	burden voltage ≤ 3 V burden voltage ≤ 3 V
Shortest span	0.5 mA	
Range start/end	freely programmable within the limits in 0.01 mA steps	
Overrange/underrange	according to NAMUR NE 43	
Sampling cycle	Channel 1 - 18: 125 ms in total	
Input filter	2nd order digital filter; filter constant adjustable from 0 to 10.0 sec	
Electrical isolation	see Electrical dat and electrical isolation	
Resolution	>14 bit	

¹ The linearization accuracy refers to the maximum measuring range. The linearization accuracy is reduced with short spans.

Transducer short circuit/break

	Short-circuit ¹	Break ¹
Thermocouple	not detected	detected
Resistance thermometer	detected	detected
Resistance transmitter	not detected	detected
Potentiometer	not detected	detected
Voltage $\leq \pm 210$ mV	not detected	detected
Voltage $> \pm 210$ mV	not detected	not detected
Current	not detected	not detected

Binary inputs/outputs (option)

Input or output	configurable as input or output
Number	8, 16 or 24, depending on the device version, to DIN VDE 0411, Part 500; max. 25 Hz, max. 32 V
Input - level - counting frequency	logic "0": -3 to +5 V (input current max. ± 1 mA), logic "1": 12 to 30 V ($2.5 \text{ mA} \leq \text{input current} \leq 5 \text{ mA}$) 8 Hz
High-speed input - task - counting frequency	the first two binary inputs of each module (B1, B2, B9, B10, B17, B18), if the module is not fitted with relays or 6 analog inputs count function, e. g. for flow measurement 10 kHz
Output - type - level - sampling cycle	open-collector output, switches relative to positive voltage logic "0": transistor is inhibited (max. permissible voltage across switching transistor 30 V, max. leakage current 0.1 mA) logic "1": transistor is switched on (max. voltage across switching transistor 1.6 V, max. current 50 mA) at least 1 sec (1 Hz)

Outputs

1 relay (standard)	changeover (SPDT), 3 A, 230 V AC ¹
6 relays (option)	changeover (SPDT), 3 A, 230 V AC ^{1,2}

¹ With resistive load. ² It is not permissible to mix SELV circuits and supply circuits.

Interfaces

RS232/RS485 (connector 7) - protocol - baud rate - modem - connector - external inputs	Qty. 1, switchable between RS232 and RS485 Modbus master, Modbus slave and barcode reader 9600, 19200, 38400 can be connected SUB-D via the Modbus master/slave function, 24 analog and 24 binary
RS232 for barcode reader (connector 2) - protocol - baud rate - connector - external inputs	Qty. 1 Modbus master, Modbus slave and barcode reader 9600, 19200, 38400 SUB-D via the Modbus master/slave function, 24 analog and 24 binary
Ethernet (connector 6) - quantity - protocols - baud rate - connector - data format	max. 1 TCP, IP, HTTP, DHCP, SMTP, ModbusTCP 10 Mbits/sec, 100 Mbits/sec RJ45 HTML
USB host (connector 5) - quantity - use - max. current	2 (or 1 with stainless steel front), connector 5 and front connector (not with stainless steel front); no parallel operation for connecting a memory stick 100 mA
USB device (connector 15) - quantity - use	2 (or 1 with stainless steel front), connector 15 and front connector (not with stainless steel front); no parallel operation) for connecting to the (master) computer

Screen

Resolution / size	320 x 240 pixels / 5.5"
Type / number of colors	TFT color screen / 256 colors
Screen refresh rate	> 150 Hz
Brightness setting	adjustable on instrument
Screen saver (switch-off)	Via timer or control signal

Electrical data

Supply voltage (switch-mode PSU)	100 - 240 V AC +10/-15 %, 48 - 63 Hz or 20 - 30 V AC/DC, 48 - 63 Hz (ELV)
Electrical safety	to EN 61 010, Part 1, August 2002 overvoltage category II, pollution degree 2 terminal for PE conductor
Protection class I	
Test voltages (type test)	
- mains supply circuit to meas. circuit	with AC supply: 2.3 kV/50 Hz, 1 min, with AC/DC supply: 2.3 kV/50 Hz, 1 min
- mains supply circuit to housing (protective conductor)	with AC supply: 2.3 kV/50 Hz, 1 min, with AC/DC supply: 2.3 kV/50 Hz, 1 min
- measuring current circuits to meas. current circuit and housing	500 V/50 Hz, 1 min
- electrical isolation between analog inputs	up to 30 V AC and 50 V DC
Supply voltage error	< 0.1 % of range span
Power consumption	approx. 40 VA
Data backup	CompactFlash memory card
Electrical connection	
- mains supply and relays	at rear through pluggable screw terminals, 5.08 mm raster, max. conductor cross-section $\leq 2.5 \text{ mm}^2$ or $2 \times 1.5 \text{ mm}^2$ with ferrules
- analog and binary inputs	at rear through pluggable screw terminals, 3.81 mm raster, max. conductor cross-section $\leq 1.5 \text{ mm}^2$

Environmental influences

Ambient temperature range	0 to +50 °C
Ambient temperature effect	0.03 %/ °C
Storage temperature range	-20 to +60 °C
Climatic conditions	$\leq 75\%$ relative humidity, no condensation
EMC	EN 61 326-1
- interference emission	Class A - only for industrial use - to industrial requirements
- immunity to interference	

Housing

Housing front	zinc die-casting, optionally in stainless steel (option)
Housing type	housing for flush-panel mounting to IEC 61 554, in stainless steel
Bezel size	144 mm x 144 mm to IEC 61 554
Depth behind panel	193 mm (incl. terminals)
Panel cut-out	$138^{+1.0} \text{ mm} \times 138^{+1.0} \text{ mm}$ to IEC 61 554
Panel thickness	2 - 40 mm
Housing mounting	in panel to DIN 43 834
Operating position	unrestricted, but taking into account the viewing angle of the screen, horizontally $\pm 65^\circ$, vertically $+40^\circ$ to -65°
Enclosure protection	to EN 60 529 Category 2, front IP65, rear IP20
Weight	approx. 3.5 kg

Approvals/marks of conformity

Mark of conformity	Testing laboratory	Certificates / certification numbers	Test basis	valid for
c UL us	Underwriters Laboratories	E352967	UL 61010-1 CAN/CSA-C22.2 No. 61010-1	the flush-mounted instrument; not in conjunction with extra code 350





CompactFlash memory card and USB interfaces behind housing door.

Control knob to rotate and press

Instrument Description

Hardware

The DataVU7 recorder has a modular design. The basic form consists of a PSU board (incl. relays) and a CPU board (incl. Ethernet, RS232/RS485, RS232 for barcode reader and USB) Module slots 1, 2 and 3 can be fitted with the following options, 6 analog inputs, 3 analog inputs & 8 binary inputs/outputs or slot 3 can be fitted with a module with 6 relays. As an option, the PSU board can be equipped with PROFIBUS-DP communications.

Data recording

Measurements are logged continuously with a 125 ms sampling cycle, where reports are compiled and limits checked.

Measurements are transferred to the main memory of the instrument, according to the programmed cycle time and stored value (max, min, average, min & max, instantaneous value or economy mode). The recorder saves the data in groups, and an input can be assigned to several groups to a maximum of 9.

Main memory (SRAM)

The data stored in the SRAM are regularly copied to the internal memory in 20 kbyte blocks.

Internal memory

When a block in the main memory has been filled, it is written to the internal memory with a capacity of 256 Mbytes.

Every write action is monitored, to immediately identify any errors in saving the data.

The instrument monitors the capacity of the internal memory and activates one of the "memory alarm" signals when the capacity falls below the configurable residual capacity level. These signals can be used, for instance, to operate the alarm relay. The memory is written as FIFO First-In-First-Out, i. e. when the memory is full, the oldest data is automatically overwritten by the new data. Data from the internal memory can be shown as a history presentation on the recorder. The size of this memory can be configured.

Data transfer to the PC

Data transfer from the recorder to external CompactFlash memory card (not available with stainless steel front), USB memory stick or via a communications interface (USB device, RS232, RS485, Ethernet).

Data security

The data are stored in an encrypted form in a proprietary format. This ensures a high level of data security. If the recorder is disconnected from the supply, then:

- RAM and clock time are buffered by a lithium battery (standard) ≥ 10 years or with a storage capacitor ≥ 2 days (ambient temperature -40 to $+45$ °C),
- measurement and configuration data in the internal memory will not be lost.

Recording duration

Depending on the configuration of the instrument, the recording period can vary over a considerable range (from a few days up to several months).

Report

For each channel of a group, a report (maximum/minimum/average or integrator) can be run over defined periods.

Batch reports

Three batch reports can be created simultaneously in the recorder. The measured data, start, end and duration of each batch can be displayed together with a batch counter and freely defined texts, on the recorder and within the Evaluation Software on request, a barcode reader can be used to start batches and read batch texts.

Limit level to change operating mode

Over/under limit conditions trigger alarms. These can be used, for instance, as a control signal to change the operating mode. The storage cycle and recorded value can be configured separately for all three operating modes. An alarm delay function can be filter out brief occurrences of limit conditions, so that no alarm is generated.

Normal operation

If the instrument is **not** in timed or event operation, normal operation is active.

Event operation

Event operation is activated/deactivated by a control signal (binary input, group/combination alarm, ...). As long as the control signal is active, the instrument will be in event operation.

Timed operation

Timed operation is active on a daily basis within a programmable time period. The operating modes have different priorities.

Counters/integrators

27 additional internal channels are available as counters, integrators, operating time counters or for flow measurements.

These counters are controlled through the digital inputs, the alarms, or via the logic channels. The analog channels can be used for the integrators.

Numerical indication is shown in a separate window, with up to 9 digits. The acquisition time can be selected as: periodic, daily, weekly, monthly, yearly as well as external, total (overall count) or daily from ... to. Up to 6 binary inputs are available as high-speed counters with a 10 kHz sampling cycle rate.

Math/logic module (option)



The module for math and logic (18 channels of each) enables, for example, the combination of analog channels, and also the combination of analog channels with counters and digital inputs. Operators for formulae are: +, -, *, /, SQRT(), MIN(), MAX(), SIN(), COS(), TAN(), **, EXP(), ABS(), INT(), FRC(), LOG(), LN(), humidity, moving average or !, &, |, ^, as well as (and).

The math and logic module can only be configured through the setup program.

Operation and configuration

On the recorder

The instrument is configured from the control knob (or with stainless steel front, from the touchpad) on the front panel under menu guidance.

-  Shift current menu position (cursor) to the left or upwards.
-  Shift current menu position (cursor) to the right or downwards.
-  When the control knob is pressed, the current function is executed.

Example:



-  Rotate control knob to the left.



-  Press control knob.

Result: The menu for the alarm and event list is called up.

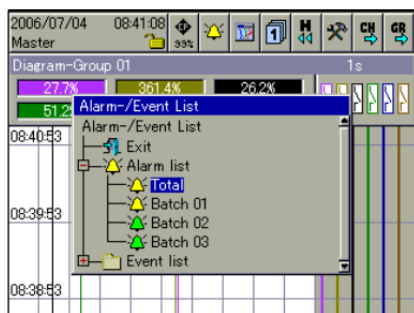

-  Rotate control knob to the left.

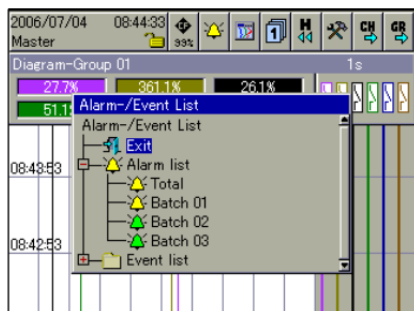

-  Press control knob.

Result: The menu for the alarm and event list is closed again.



Integrated user lists (different users with different authorizations) protect the recorder against unauthorized access.

Through the setup program

As an alternative to the configuration from the control knob on the recorder, the instrument can also be configured through the setup program.

Communication between the setup program and the paperless recorder is made through the:

- USB device interface,
- serial interface,
- Ethernet interface,
- CompactFlash memory card or
- USB memory stick.

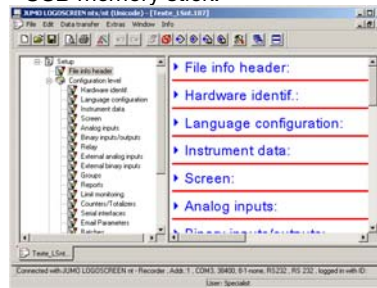

The configuration data can be archived on a data storage medium and output to the printer.

Operating language

Two languages (see order details) are integrated in the instrument ex-factory. The setup program is used to change the operator language. The languages available: English, French, German, Russian, Japanese, Chinese, Italian, Romanian, Czech, Hungarian, Polish and Greek. Other language versions (with Unicode capability) can be created.

Web server

The web server is integrated in the DataVU7 as standard. Four different modes of presentation are available:

- online visualization
- three freely programmable HTML pages
- current batch reports
- 4-way view (1 to 4 recorders or different visualizations)

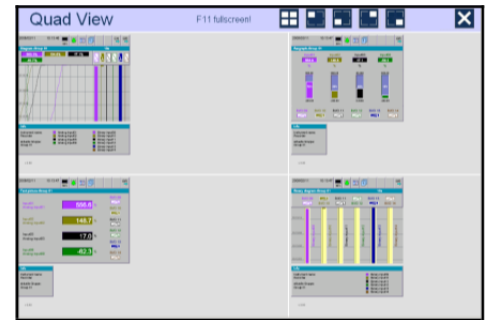

On the PC side, the web server can be addressed with web browser. For visualizing graphics, an SVG Viewer (from Adobe®, for instance) must be installed on the PC in addition to the Internet Explorer.

Process images (editor)

The setup program can create process images and transfer them to the paperless recorder for display. Up to 25 objects (images, analog channels, binary channels, texts, ...) can be used in a process image.

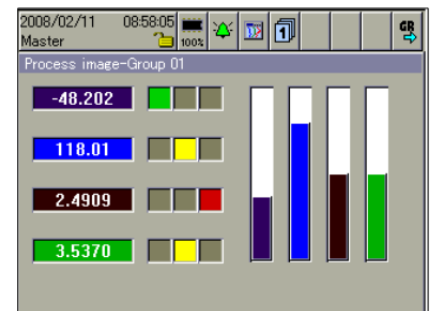

One process image is integrated in the paperless recorder ex-factory.

Visualization on the instrument

Operator level

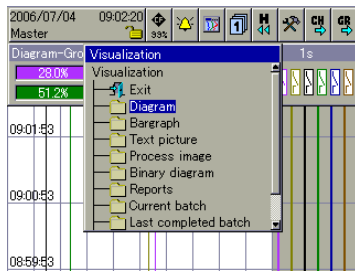

Selection of visualization

Vertical diagram

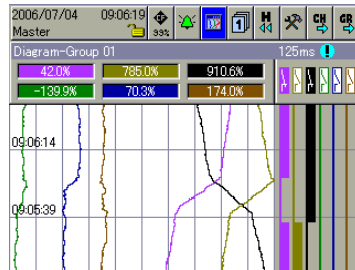

Recorder chart presentation of analog and binary channels

Display of scaling and limit markers of a channel (can be switched on/off)
Numerical display of current analog channels

Bar graph presentation

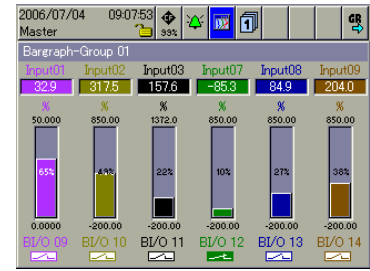

Bar graph presentation of analog channels

On / Off presentation of binary channels
Display of current analog channels with scaling and limit markers
Color change of bar graph to red when limits are infringed

Numerical presentation

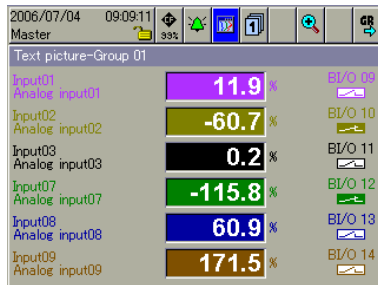

Large numerical presentation of analog channels, including the channel name and description

Each analog channel can be switched to the foreground
On / Off presentation of binary channels

Numerical 1ch presentation

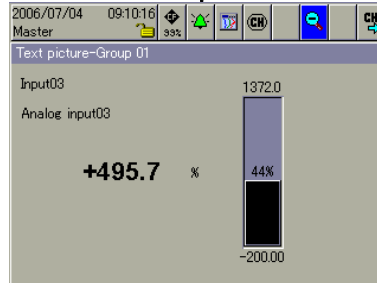

Clear presentation of an analog channel

An analog input is shown simultaneously as a bar graph and a number
Display of channel name and description
Display of scaling and limit markers

Process image

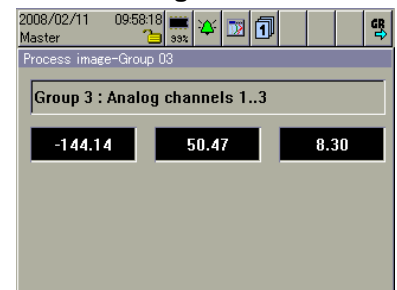

Freely configurable presentation (through the setup program) of analog and binary signals with background pictures

One process image for each group

Binary presentation

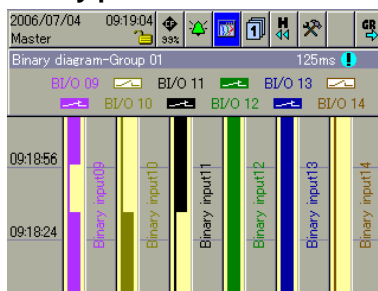

On / Off presentation of binary channels

Report

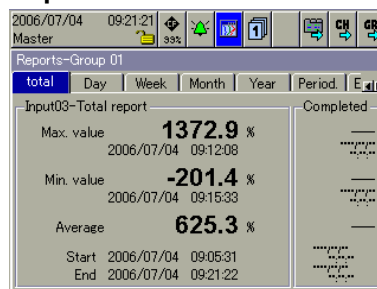

Display of different reports for the analog channels of a group
Details of minimum, maximum, - average / integral values and time period
Display of the previous report

Batch reports

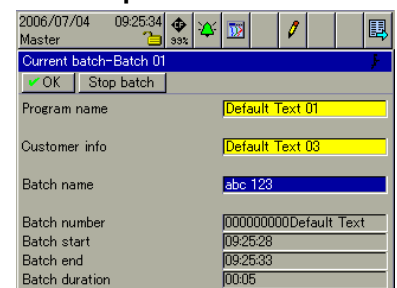

3 batches documented simultaneously

Changeover between current and completed batch reports
Electronic signature is possible
Batch texts via interface and barcode reader, among others

Counter/integrator presentation

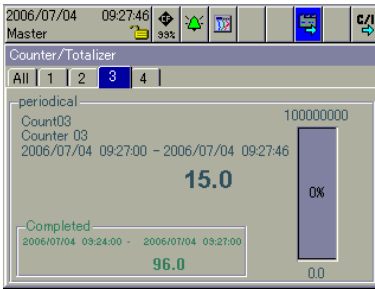

Presentation of up to 27 counters or integrators
Changeover between individual and overall display
Display of the current and the most recently completed count

Group selection

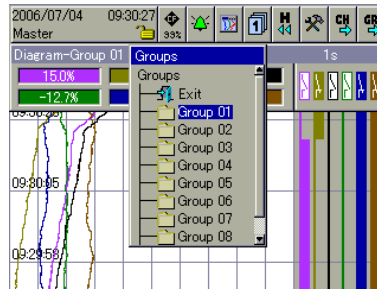

Up to 9 groups are configurable
Up to 6 analog and 6 binary channels can be shown for each group
Measurement signals can be used in several groups

History presentation

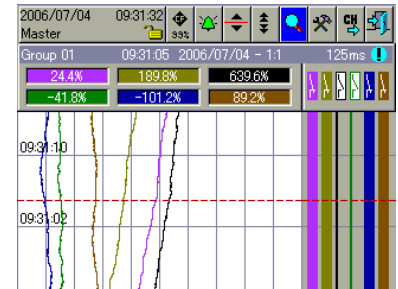

All stored measurement data are shown as curves at different zoom levels
Display of scaling and limit markers of a channel
Numerical display of the measurements of the analog channels at the cursor position
Shifting of the visible section within the stored measurement data

Presentation of alarm lists

Date	Time	Description
2006/07/04	09:47:22	Alarm Lim02
2006/07/04	09:47:15	Alarm Lim01
2006/07/04	09:47:15	I/O 9 not calibrated
2006/07/04	09:47:15	High Alarm AID8
2006/07/04	09:47:15	I/O 8 not calibrated
2006/07/04	09:47:15	I/O 7 not calibrated
2006/07/04	09:47:15	High Alarm AID2

Display of current alarms
For the instrument as a whole or batch-related
Up to 150 entries visible on the recorder

Presentation of event lists

Date	Time	Description
2006/07/04	09:35:19	CF card removed
2006/07/04	09:35:19	CF card in place
2006/07/04	09:35:16	CF card removed
2006/07/04	09:34:16	POWER ON
2006/07/04	09:33:42	POWER OFF
2006/07/04	09:26:29	Batch 01 end
2006/07/04	09:25:28	Batch 01 start
2006/07/04	09:05:31	NEW CONFIGURATION

Display and storage of events and alarms
For the instrument as a whole or batch-related
Up to 150 entries visible on the

Configuration

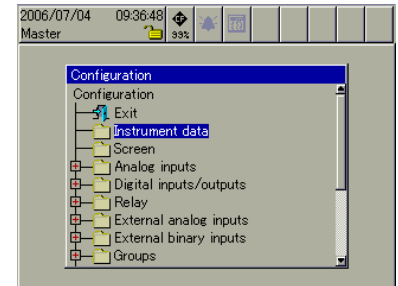

Configuration on the recorder itself, by rotating and pressing the control knob
Configuration through the setup program

Visualization through the web browser

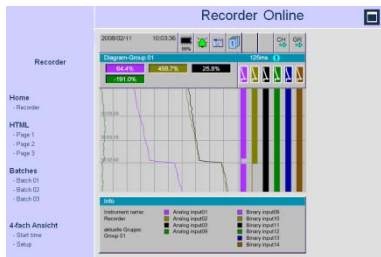

Online visualization of a recorder
Selection of (max.) three customized HTML pages (created on request)

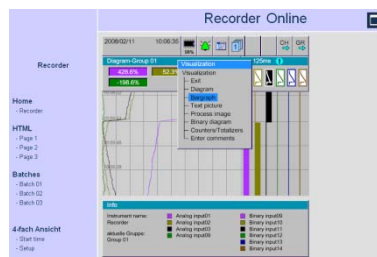

Navigation through the different recorder visualizations (curves, bar graph, text, process, ...)



Max. four recorders or four different visualizations simultaneously

PC programs

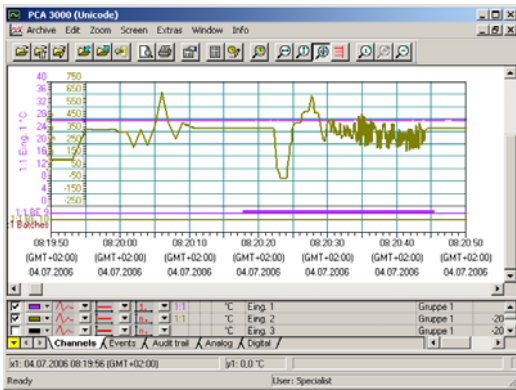

PC Evaluation Software (PCA3000)

The PC Evaluation Software (PCA3000) is a program which runs under Windows 2000/XP/Vista/Win7, and is used to manage, archive, visualize and evaluate the recorder data.

- The data from differently configured instruments are recognized by the PC Evaluation Software and stored in an archive database. All management is fully automatic. The user only has to manually allocate an identifier (supplementary description).
- The user can at any time gain access to certain data sets which can be distinguished by the identifier. It is also possible to restrict the time periods to be evaluated.
- Any analog or binary channels of a DataVU7 recorder (even from different groups) can subsequently be combined into PCA groups in PCA3000.

- Since each group is displayed in a separate window, several groups can be shown simultaneously on the screen and compared.
- Operation by mouse or keys.
- Using the export filter, it is possible to export the stored data, so that they can be processed in other programs such as Excel.
- The PC Evaluation Software PCA3000 has network capability, i.e. several users can obtain data from the same archive file (*.177) in a network directory, independently of each other.

PCA Communications software (PCC)

- Data can be read out from the recorder via the USB device interface, the serial interface (RS232/RS485) or via the Ethernet interface. The data can be read manually or automatically (e.g. daily at 23.00 hrs).
- Data can also be retrieved via remote control, through a modem.

Functional overview

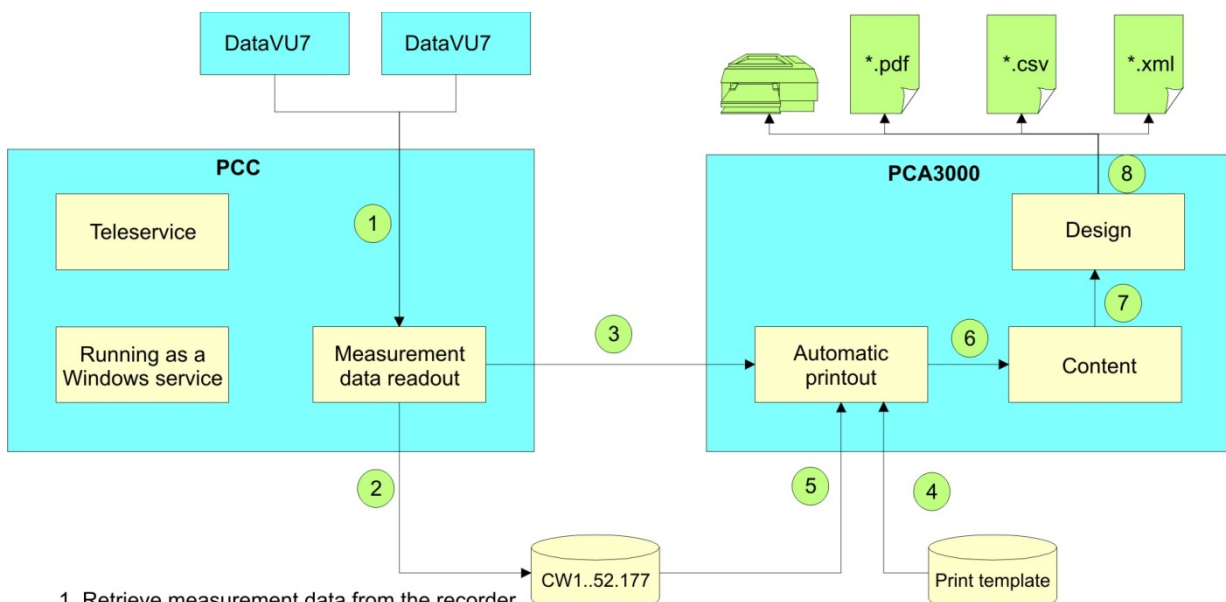

1. Retrieve measurement data from the recorder.
2. Store measurement data in archive files (*.177).
3. Activate "automatic printout" in PCA3000.
The print template is selected within PCC.
4. Read the print template. Print templates are created within PCA3000.
5. Data transfer from archive.
6. Determine the content defined in the print template.
7. Use the determined content in the defined design.
8. Output the completed design in the defined formats.

Interfaces

USB interfaces (standard)

RS232/RS485 interface (standard)

RS232 interface for barcode reader (standard)

Ethernet interface (standard)

PROFIBUS-DP interface (option)

USB interfaces

With USB interfaces, a distinction is made between the host and the device interface.

A USB memory stick can be attached to the host interface. The device interface, in conjunction with a standard commercial USB cable, is used to operate the setup program. The paperless recorder without stainless steel front has host and device interfaces connected in parallel on both the front and back panels, of which only one of each type can ever be used. The paperless recorder with stainless steel front has only one host and one device interface at the rear panel.

RS232/RS485 interface

Current process data, as well as specific device data, can be read via the RS 232 or RS 485 interface. Data in the internal memory can also be read by the PC Evaluation Software PCA3000 and the PCA Communications Software (PCC). The RS 232 interface permits a maximum lead length of 15 m, the RS 485 interface 1.2 km. Connection is by a 9-pin SUB-D connector on the back of the instrument. Modbus (master and slave) protocols are available, and the transmission mode used is RTU (Remote Terminal Unit).

RS232 for barcode reader

A barcode reader can be used to start or stop batch reporting, and to

	USB Host/Device	RS232 RS485	Ethernet	PROFIBUS-DP	External CF card
Read current measurement data	yes (device only)	yes	yes	yes	no
Write current measurement data	no	yes	yes	yes	no
Read out stored measurement data	yes	yes	yes	no	yes
Read /write configuration	yes	yes	yes	no	yes
Write user list	yes	yes	yes	no	yes

set batch texts (customer information, batch number...).

The barcode reader is operated via the RS232/RS485 interface, and the RS232 interface for the barcode reader can also be used as a Modbus master or slave.

Ethernet interface

The Ethernet interface can be connected to local networks for communication between the recorder and the setup program and the PCA Communications Software. The IP address is set permanently through the instrument configuration, in the setup program or automatically received from a DHCP server. The integrated web server allows simultaneous access by several PCs to 3 HTML and 3 batch pages. Transmission protocol: TCP/IP
Network type: 10BaseT, 100BaseT

PROFIBUS-DP interface

The recorder can be integrated into a fieldbus system according to the PROFIBUS-DP standard via the PROFIBUS-DP interface. This PROFIBUS version, in particular, is designed for communication between automation systems and distributed peripheral field devices.

Data is transmitted serially according to the RS485 standard, to a maximum 12 Mbits/sec. Using the included project design tool (GSD generator; GSD = device master file), an application-specific GSD file is created, which is used to integrate the recorder within the fieldbus system.

External CompactFlash memory card (CF)

The external CompactFlash memory card (CF) is used to transfer the data from the internal memory to the PC, excluding versions with Stainless steel front. Configuration data can be created on the PC and then transferred to the recorder from the memory card. On the PC side, data on the card is accessed using a read/write device (CompactFlash reader/writer).

External inputs via interface

The paperless recorder can acquire and store up to 24 external analog inputs and 24 binary inputs. Furthermore, the interfaces can be used to enter comments in the event list of the recorder.

Connection diagram

Rear view with pluggable screw terminals

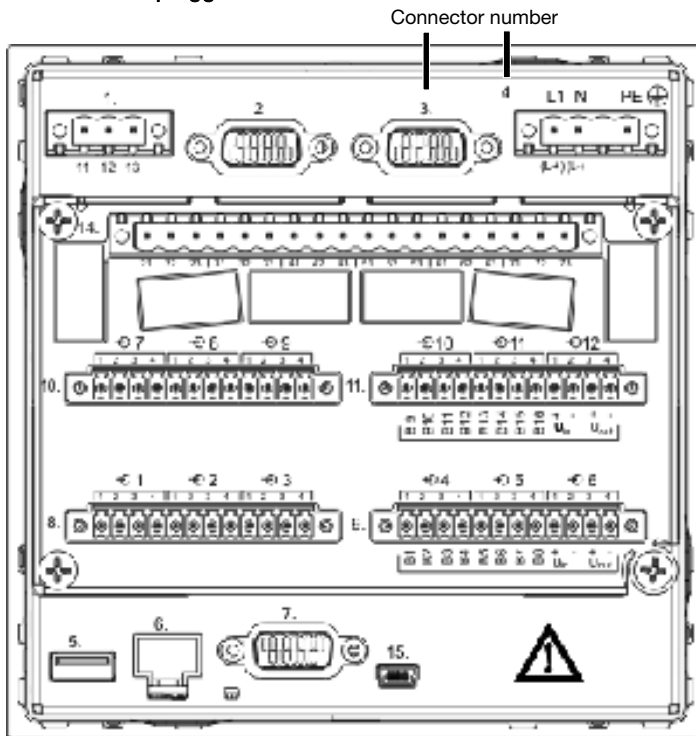

Module slot 3 (top)
fitted with one relay card.

Module slot 2 (middle)
fitted with 6 analog channels or
3 analog channels and
8 binary inputs/outputs.

Module slot 1 (bottom)
fitted with 6 analog channels or
3 analog channels and
8 binary inputs/outputs.

Instrument variant 1

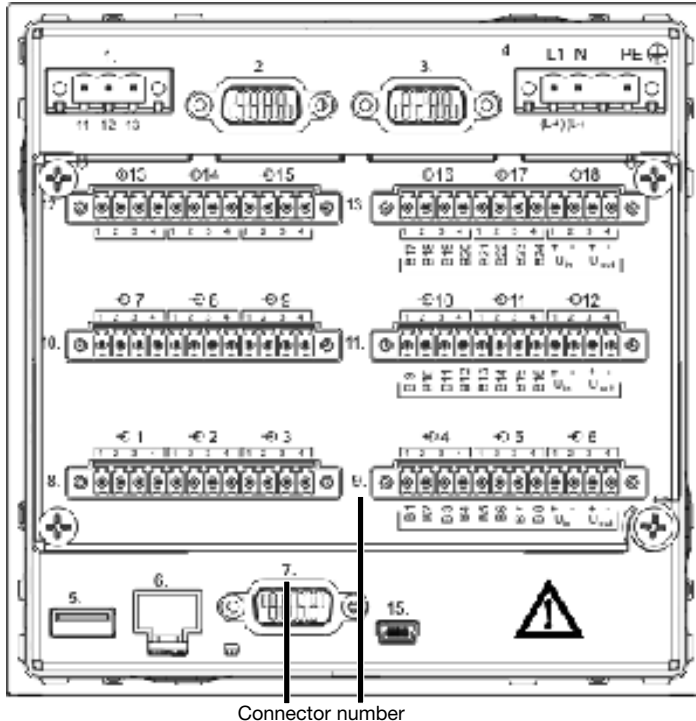





Module slot 3 (top)
fitted with 6 analog channels or
3 analog channels and
8 binary inputs/outputs.

Module slot 2 (middle)
fitted with 6 analog channels or
3 analog channels and
8 binary inputs/outputs.

Module slot 1 (bottom)
fitted with 6 analog channels or
3 analog channels and
8 binary inputs/outputs.

Connector number

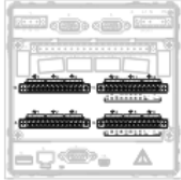
Instrument variant 2

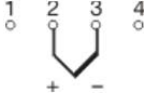
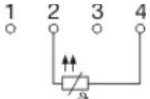
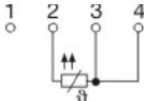
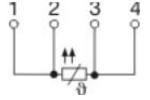
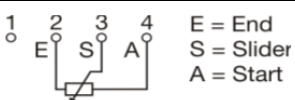
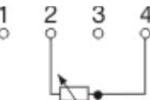
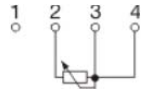
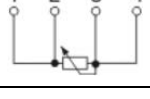
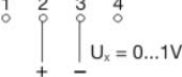
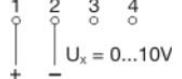
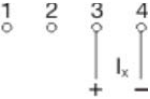
Terminal assignment	Connector	Diagram
Supply		
Supply as on nameplate	Connector 4 L1 (L+) N (L-) PE 	
Analog inputs		
Thermocouple	Connectors 8 to 11 (input 1 to 12) for instrument variant 1  or Connectors 8 to 13 (input 1 to 18) for instrument variant 2 	
RTD in 2-wire circuit		
RTD in 3-wire circuit		
RTD in 4-wire circuit		
Resistance transmitter		
Potentiometer in 2-wire circuit		or 
Potentiometer in 3-wire circuit		
Potentiometer in 4-wire circuit		
Voltage input 0 - 1 V		
Voltage input 0 - 10 V		
Current input		

Binary inputs/outputs

Configuration (through the setup program or on the instrument) defines which are binary inputs and which are outputs.

B1 ... B8

voltage-controlled
LOW = -3 to +5 V DC
LOW = 12 to 30 V DC

internal power supply 24 V/60 mA (U_{out})

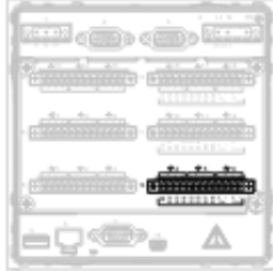

Connector 9
only on modules with
3 analog inputs

B1 binary input/
output 1

...
B8 binary input/
output 8

U_{in+} external power
supply

U_{in-} ground

U_{out+} +24 V internal
power supply

U_{out-} ground

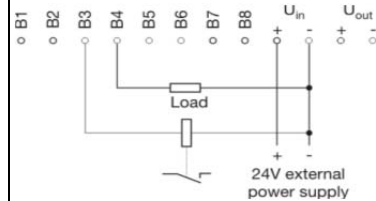

Example:

Connecting a load to binary output 4 (B4) and a solid-state relay to binary output 3 (B3) requires an external power supply.

Diagram of the connector

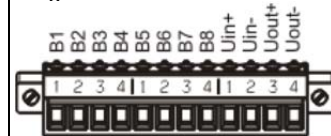

B9 ... B16

voltage-controlled
LOW = -3 to +5 V DC
LOW = 12 to 30 V DC

internal power supply 24 V/60 mA (U_{out})



Connector 11
only on modules with
3 analog inputs

B9 binary input/
output 9

...
B16 binary input/
output 16

U_{in+} external power
supply

U_{in-} ground

U_{out+} +24 V internal
power supply

U_{out-} ground









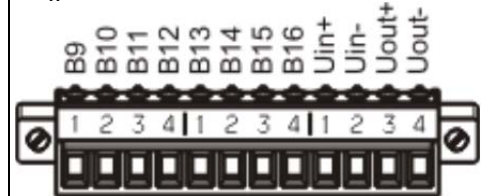



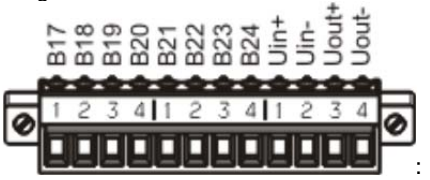

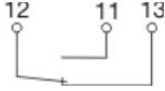

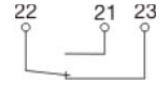
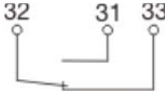
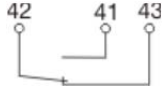
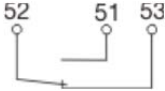
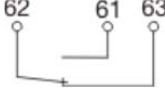
Example:

Binary input 12 (B12) is operated from the internal power supply.

Diagram of the connector:



<p>B17 ... B24</p> <p>voltage-controlled LOW = -3 to +5 V DC LOW = 12 to 30 V DC</p> <p>internal power supply 24 V/60 mA (U_{out})</p> 	<p>Connector 13 only for instr. variant 2 and for modules with 3 analog inputs</p> <p>B17 binary input/ output 17</p> <p>...</p> <p>B24 binary input/ output 24</p> <p>U_{in+} external power supply</p> <p>U_{in-} ground</p> <p>U_{out+} +24 V internal power supply</p> <p>U_{out-} ground</p>	 <p>Example: Binary input 20 (B20) is operated from the internal power supply.</p> <p>Diagram of the connector</p> 
<p>Relay outputs</p>		
<p>Relay 1 changeover (SPDT)</p>	<p>Connector 1</p> 	
<p>Relay 2 changeover (SPDT)</p>	<p>Connector 14</p> <p>only for instrument variant 1</p> 	
<p>Relay 3 changeover (SPDT)</p>		
<p>Relay 4 changeover (SPDT)</p>		
<p>Relay 5 changeover (SPDT)</p>		
<p>Relay 6 changeover (SPDT)</p>		
<p>Relay 7 changeover (SPDT)</p>		
<p>Interfaces</p>		
<p>RS232 for barcode reader 9-pin SUB-D socket connector</p>	<p>Connector 2</p> 	<p>2 RxD Receive Data 3 TxD Transmit Data 5 GND Ground</p>
<p>PROFIBUS-DP 9-pin SUB-D socket connector (extra code)</p>	<p>Connector 3</p> 	<p>3 RxD/TxD-P Receive/Transmit Data-Pos. B conductor 5 DGND Ground for data transmission 6 VP Supply voltage-Pos. 8 RxD/TxD-P Receive/Transmit Data-Neg. A conductor</p>

USB host interface for connecting memory sticks	Connector 5 	The recorder without stainless steel front also has a USB host interface on the front panel, connected in parallel. The two interfaces cannot both be operated at the same time.
Ethernet RJ45 socket connector	Connector 6 	1 TX+ Transmit Data + 2 TX- Transmit Data - 3 RX+ Receive Data + 6 RX- Receive Data -
RS232 9-pin SUB-D socket connector (switchable to RS485)	Connector 7 	2 RxD Receive Data 3 TxD Transmit Data 5 GND Ground
RS485 9-pin SUB-D socket connector (switchable to RS232)	Connector 7 	3 TxD+/RxD+ Transmit/Receive Data + 5 GND Ground 8 TxD-/RxD- Transmit/Receive Data -
USB host interface for connecting a PC	Connector 15 	The recorder without stainless steel front also has a USB device interface on the front panel, connected in parallel. The two interfaces cannot both be operated at the same time.

Overview of the electrical isolation

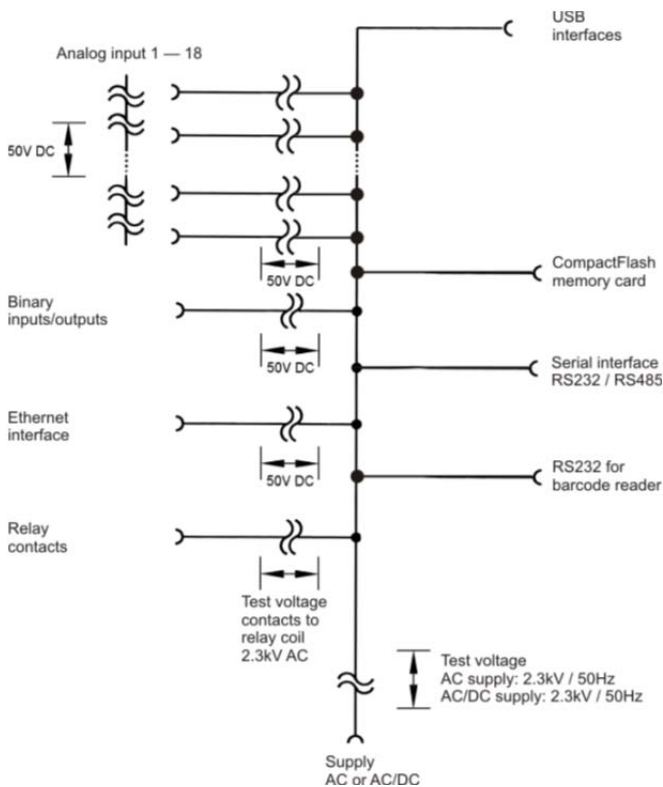

Dimensions

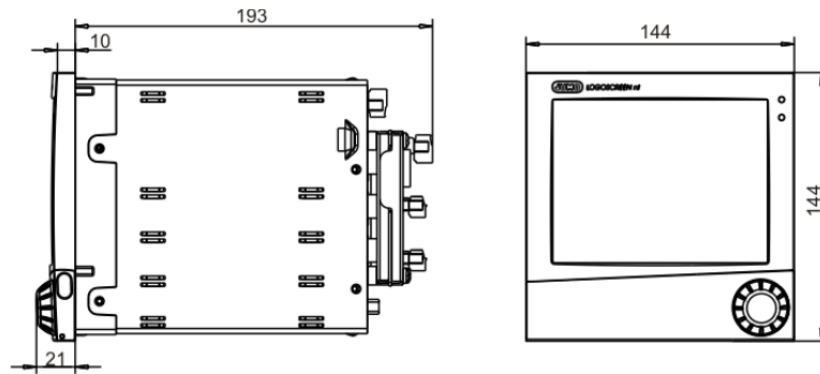

Recorder with die-cast zinc front

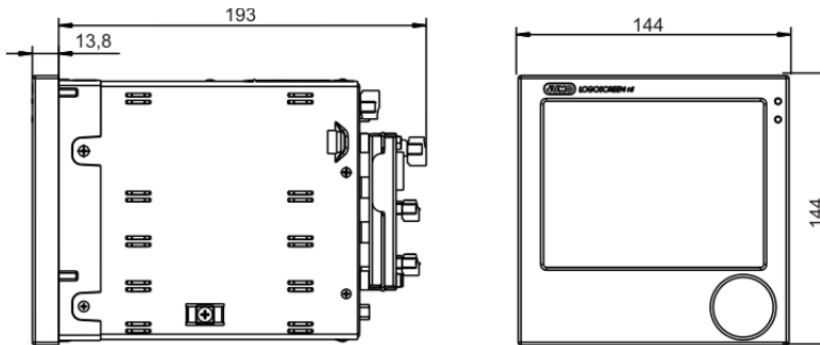

Recorder with stainless steel front (extra code)

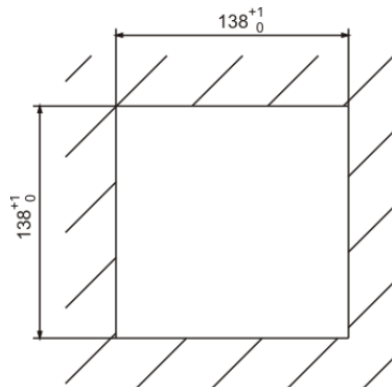

Panel cut-out

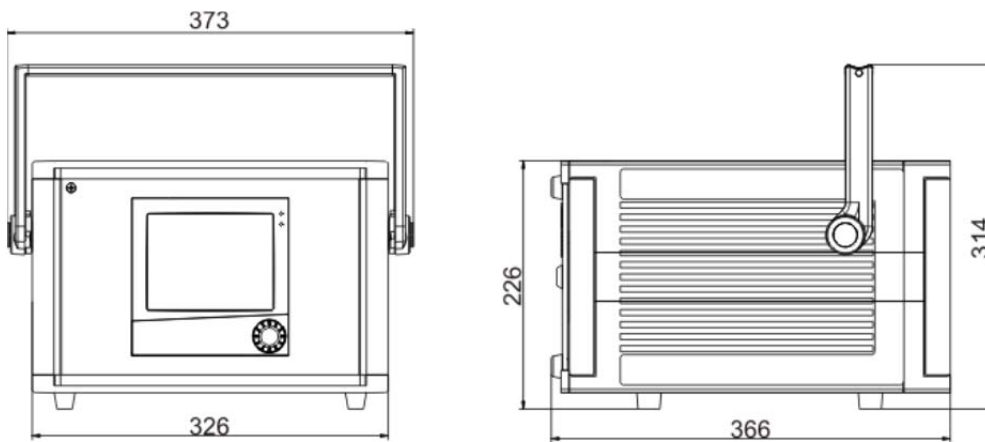

Universal carrying case option - TG-35

Ordering information

	VU7	X	-	X	-	X	-	X	-	X	-	X
Base Unit		↓		↓		↓		↓		↓		↓
INPUT SLOT 1												
none		0										
3 Universal inputs and 8 DI/DO		3										
6 Universal inputs		6										
INPUT SLOT 2				↓								
none				0								
3 Universal inputs and 8 DI/DO				3								
6 Universal inputs				6								
INPUT SLOT 3						↓						
none						0						
3 Universal inputs and 8 DI/DO						3						
6 Universal inputs						6						
6 Relay outputs						R						
Power supply options								↓				
100 - 240V AC, 48-63 Hz								0				
20 - 30V AC/DC, 48-63 Hz								1				
Option 1										↓		
Lithium battery for memory										0		
Lithium battery for memory + Math function module										1		
Lithium battery for memory + PROFIBUS DP interface										2		
Lithium battery for memory + Mathfunction module + PROFIBUS DP interface										3		
Capacitor for memory buffering										4		
Capacitor for memory buffering + Mathfunction module										5		
Capacitor for memory buffering + PROFIBUS DP interface										6		
Capacitor for memory buffering + Mathfunction module + PROFIBUS DP interface										7		
Option 2												↓
none												0
Stainless steel front												1
Universal carrying case												2

Accessories

Setup PC software
 PCC Communication PC software
 PCA3000 Evaluation PC software
 CF-card memory 256MB
 CF-card memory 1GB

Part Code

DV7PCSETUP
 DVPCC
 DVPCEVAL
 DVCF256
 DVCF1000

West Control Solutions – International Sales and Support

CHINA

Setra-ICG (Tianjin Co., Ltd.)
 No.28 Wei 5 Road,
 The Micro-Electronic Industry Park TEDA,
 Xiqing District, Tianjin 300385
 Tel: +86 22 8398 8098 Fax: +86 22 8398 8099
 Sales Hotline: 400 666 1802
 e-mail: China@West-CS.com

GERMANY

PMA Prozeß- und, Maschinen- Automation GmbH,
 Miramstraße 8, 7D -34123 Kassel
 Tel: +49 (561) 505-1307 Fax: +49 (561) 505-1710
 e-mail: EnquiriesGermany@West-CS.com

USA

West Control Solutions
 1675 Delany Road, Gurnee, IL 60031-1282
 Tel: 800 866 6659 Fax: 847 782 5223
 e-mail: InquiriesUSA@West-CS.com

FRANCE

Tel: +33 (1) 77 80 90 40 Fax:+33 (1) 77 80 90 50
 e-mail: EnquiriesFrance@West-CS.com

UNITED KINGDOM

West Control Solutions
 The Hyde Business Park, Brighton, East Sussex, BN2 4JU
 Tel: +44 (0)1273 606271 Fax: +44 (0)1273 609990
 e-mail: EnquiriesUK@West-CS.com

Brochures and datasheets are available for the complete range of West Control Solutions products, contact your local sales office or visit our website at: www.west-cs.com for more information.

Specifications are subject to change without notice, as a result of continual development and improvement, E&OE